

# ARG ILLA TERRACQUE





**LE TONALITÀ DEI COLORI  
DELLA TERRA CAMBIANO  
NEL CORSO DELLE ORE E  
DELLE STAGIONI**

THE COLOURS OF THE  
GROUND CHANGE OVER  
HOURS AND SEASONS



**ARGILLA TERREACQUE** riscopre le espressioni più naturali delle terre faentine, le argille, creando una gamma cromatica dalla tonalità pastello, in cui la materia diventa protagonista.

**ARGILLA TERREACQUE** rediscovers the most natural expressions of the Faentinian lands, the clays, creating a chromatic range with a pastel shade, where the material becomes the main subject.

Le 6 tonalità di colore sono fra loro affini, interpretate da due diverse superfici: QUARTZ e MATERIAL per rivestimenti e pavimentazioni.

Il grigio DRY e il chiaro BIACCA, colori moderni e raffinati, ricordano la presenza di una vena del gesso, determinando una tendenza fredda e rocciosa. Il marrone FOG e il bruno DARK, si presentano con tonalità più calde richiamando le argille più superficiali. VETIVER e MARINE completano la collezione con il riferimento all'acqua, naturale compendio della terra.

These 6 colours shades are available on two different surfaces: QUARTZ and MATERIAL for both floor and wall applications.

The DRY grey and the BIACCA clear, modern and refined colors, recall the presence of a vein of chalk, determining a cold and rocky trend. FOG brown and DARK brown are presented in warmer tones recalling the more superficial clays. VETIVER and MARINE complete the collection with reference to water, the natural compendium of the earth.



BIACCA

DRY

VETIVER

La superficie **MATERIAL** è opaca e al tatto presenta un lieve rilievo che ricorda un intonaco irregolare. Disponibile nello spessore sottile di  $\approx 6$  mm, è ideale per pavimentazioni e vibranti rivestimenti.

La superficie **QUARTZ** presenta una lucidatura molto naturale che ricorda i cementi levigati al quarzo. Disponibile nello spessore di  $\approx 12$  mm, è ideale per resistenti ed eleganti pavimentazioni di ambienti commerciali e residenziali.

**MATERIAL** surface is matte and reveals to the touch a slight relief, reminiscent of unfinished gypsum. Available in  $\approx 6$  mm thickness, it is ideal for floorings and vibrant coverings.

**QUARTZ** surface has a very natural brushed look, that recalls of buffed quartz cement. Available in  $\approx 12$  mm thickness, it is ideal for durable elegant floorings in both commercial and residential spaces.



≠6 mm Material / ≠12 mm Quartz

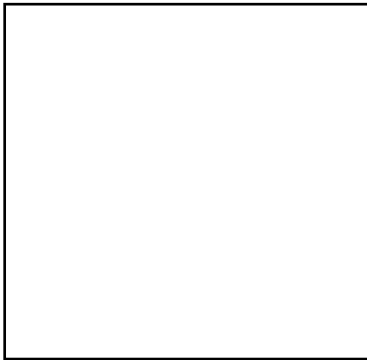

**120x120 cm**  
48"x48"



**60x120 cm**  
24"x48"

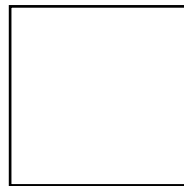

**60x60 cm**  
24"x24"

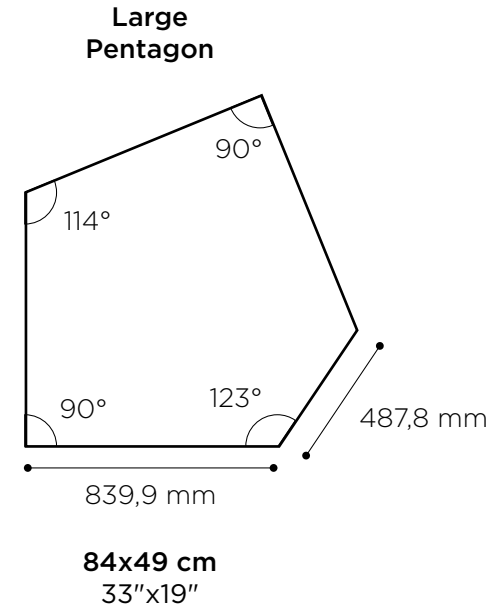

**PLAYONE MOSAICS ≠6 mm Material**

**Mosaic  
1.5x1.5**

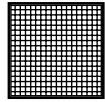

**30x30 cm  
12"x12"**

**Stripes mosaic  
1.5x120**



**15x120 cm  
6"x48"**

**PLAYONE SHAPES ≠6 mm Material**

**Small  
Hexagon**



**18x16  
7"x6"**

**Large  
Hexagon**

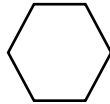

**36x31  
14"x12"**

**Diamond**



**18x31  
7"x12"**

**Small  
Pentagon**



**17x10  
7"x4"**

**Brick**



**9x18  
3 1/2"x7"**

**Plate**



**9x30  
3 1/2"x12"**

**Small**



**9x9  
3 1/2"x3 1/2"**

**PENTAGON**

**PENTAGONO**

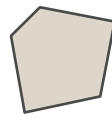

BIACCA

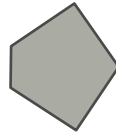

DRY

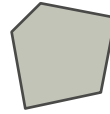

VETIVER

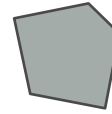

MARINE

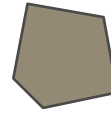

FOG

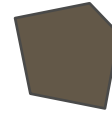

DARK

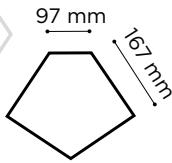
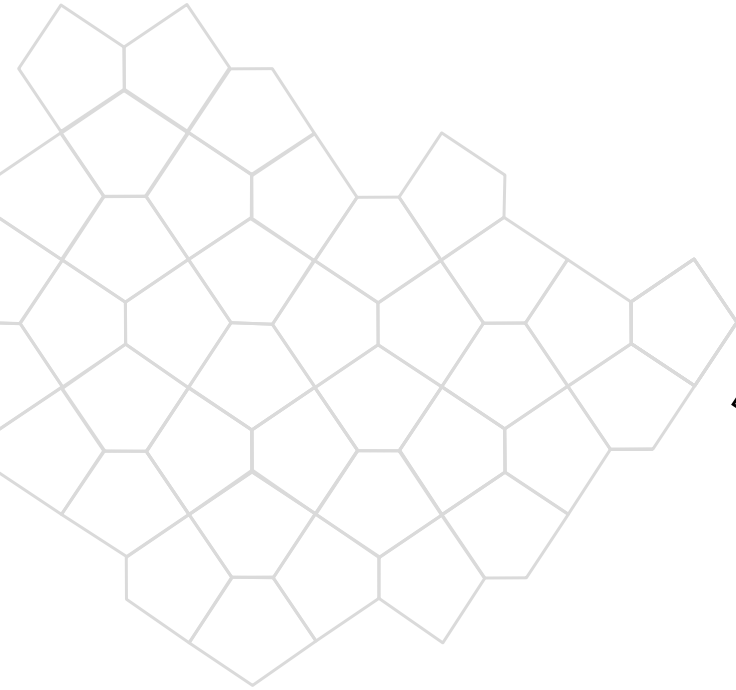

**SMALL PENTAGON**  
- MATERIAL  $\neq$  6 mm

**LARGE PENTAGON**  
- MATERIAL  $\neq$  6 mm  
- QUARTZ  $\neq$  12 mm

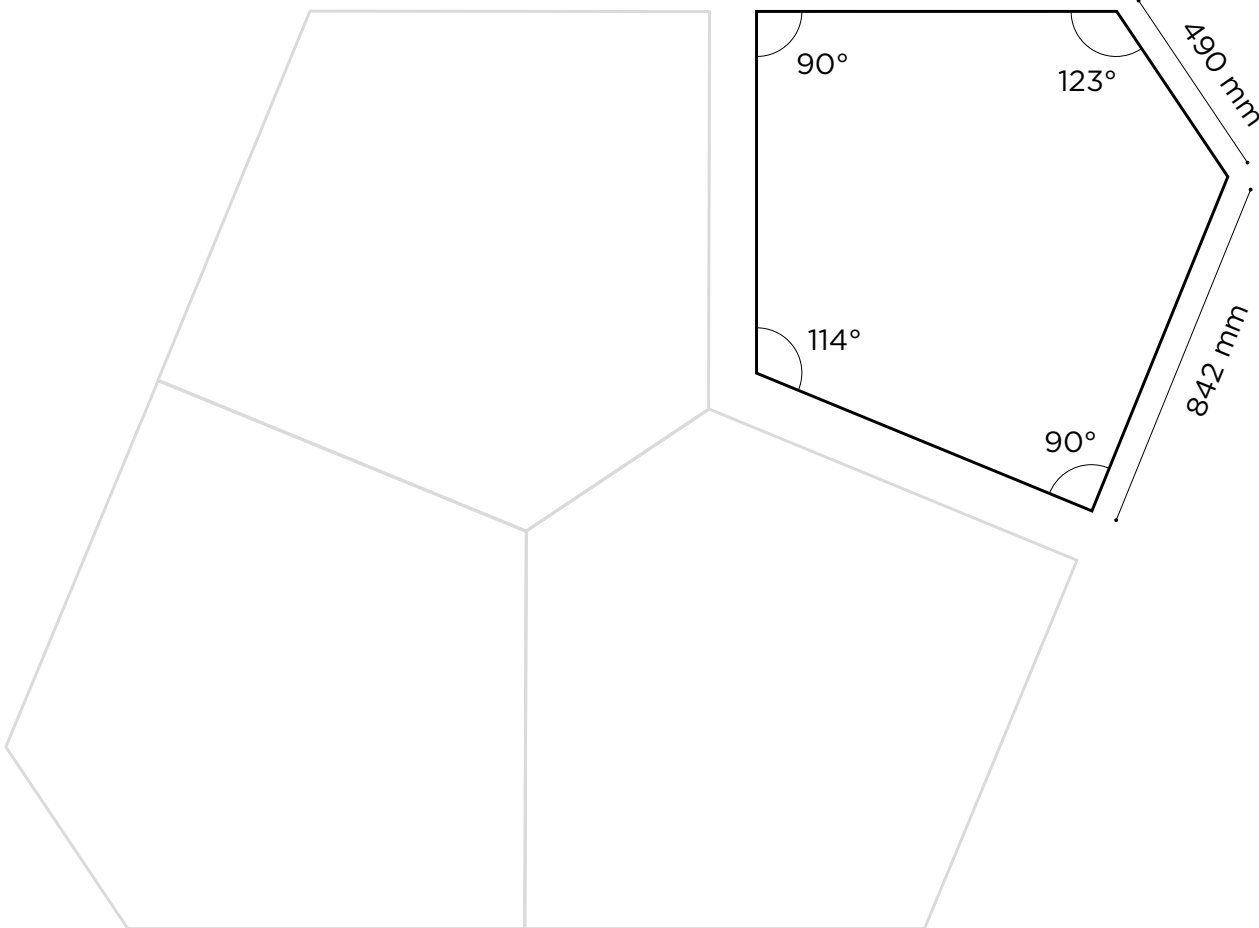





PAVIMENTO | FLOOR:  
**Argilla Fog Material Large Pentagon 84x49 / 33"x19" / #6 mm**



leci:  
glucan  
pasta  
a bit of chicken  
and ground turkey  
...  
to the ...  
cup of coffee ...



**Small Pentagon a rivestimento è un invito alla creatività con combinazioni originali che ricordando le naturali spaccature dell'argilla.**

Small Pentagon for wall finishing is an invitation to creativity with original combinations that remind us of natural clay cracks.

**1. / 2.**

PAVIMENTO | FLOOR:  
**Argilla Marine Quartz** 60x60 / 24"x24" / #12 mm

PARETE | WALL:  
**Argilla Marine - Biacca Material Small Pentagon** 17x10 / 7"x4" / #6 mm

PIANO | TOP:  
**Concrete White** #12 mm **Gigacer Service**  
ANTE | CABINETS DOOR:  
**Concrete Graphite** #6 mm **Gigacer Service**

WALL | PARETE:

**Argilla Dark Material**

Mosaic 1.5x1.5 30x30 cm / 12"x12" / #6 mm

FLOOR | PAVIMENTO:

**Argilla Fog Material**

120x120 cm / 48"x48" / #6 mm

COUNTER | BANCONE:

**Concrete Graphite Mat**

Gigacer Service #12 mm

COFFEE TABLE COUNTER TOP | PIANO DEI TAVOLINI:

**Argilla Material - All colours**

Gigacer Service #6 mm









1.

PAVIMENTO | FLOOR:

**Argilla Dark Quartz** 120x120 / 48"x48" / #12 mm

PARETE | WALL:

**Argilla Dark Material** 120x120 / 48"x48" / #6 mm

2.

PAVIMENTO | FLOOR:

**Argilla Bianca Quartz** 120x120 / 48"x48" / #12 mm

PARETE | WALL:

**Argilla Bianca Material** 120x120 e 60x120 / 48"x48" and  
24"x48" / #6 mm



PAVIMENTO | FLOOR:

**Argilla Vetiver Material** 120x120 / 48"x48" / #6 mm

**Argilla Vetiver Material Stripes Mosaic 1.5x120** / 15x120 / 6"x48" / #6 mm

PARETE | WALL:

**Argilla Vetiver Material** 60x120 / 24"x48" / #6 mm

**Argilla Vetiver Material Stripes Mosaic 1.5x120** / 15x120 / 6"x48" / #6 mm

**Light 250 Curtain** 120x250 / 24"x100" / #6 mm





## PEZZI SPECIALI SPECIAL TRIMS

### BATTISCOPIA SKIRTING

**Battiscopa 60**  
≠12 mm

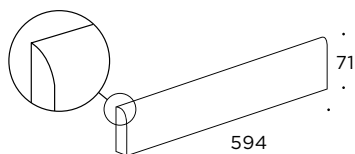

**Battiscopa 120**  
≠6 mm

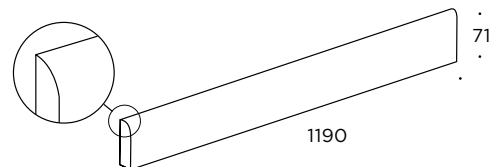

(!)  
Tutte le misure sono in millimetri  
All sizes are in millimetres

### GRADONI COSTA RETTA COSTA RETTA STEPTREADS

**Costa retta 60**

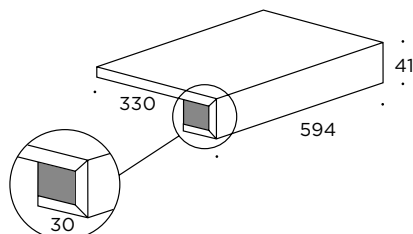

**Costa retta 120**

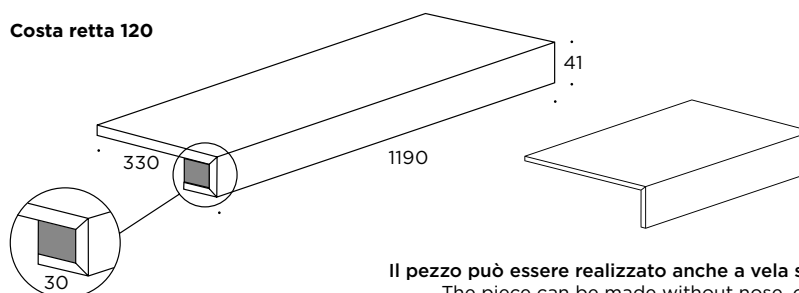

Il pezzo può essere realizzato anche a vela senza rientranza  
The piece can be made without nose, only at 90°

Per dimensioni o spessori diversi da quelli rappresentati contattare Gigacer Service  
For inquiries concerning different thicknesses and sizes from the ones indicated, please contact Gigacer Service

## NOTE TECNICHE TECHNICAL NOTES

### COEFFICIENTE DI ATTRITO / COEFFICIENT OF FRICTION LASTRE DI GRES PORCELLANATO / PORCELAIN SLABS ISO 13006 - G - Bia UGL (E ≤ 0,5%) UNI EN 14411 - G -

		SUPERFICI SURFACES	SPESSORE THICKNESS	DIN EN 16165 Annex B	DIN EN 16165 Annex A	BCR <sup>1</sup>	BRITISH PENDULUM BS7976	UNE3 41901:2017 EX (SLIDER 55#)	R9729 UPI/ EMPA	DCOF (SECTION 9.6 ANSI A 137.1.2012)
	COEFFICIENTE D'ATTRITO COEFFICIENT OF FRICTION	ARGILLA MATERIAL	≠6 mm	R10	A + B	> 0,40	-	-	-	-

I valori di resistenza allo scivolamento, coefficiente di attrito statico e dinamico, riportati sul catalogo e sul sito, sono da ritenersi puramente indicativi e non vincolanti. Ogni eventuale specifica necessità dovrà essere da noi confermata al momento dell'ordine e comunque sempre prima della posa. / The values of slip resistance and of static and dynamic friction coefficient shown in the catalogue, and in the web site are merely indicative and non-binding. Any possible specific requirement must be confirmed by us at the order and anyway always before the installation.

Non si danneggia con i detersivi chimici anticovid. / Does not damage with chemical detergents anticovid.

Quanto contenuto nel catalogo è puramente indicativo riguardo a colori e decorazioni. / Real colours and decorations might slightly differ from those depicted in this catalogue.



PAVIMENTO | FLOOR:  
**Argilla Dry Quartz** 120x120 / 48"x48" / #12 mm  
PARETE | WALL:  
**Argilla Dry Material** 120x120 / 48"x48" / #6 mm

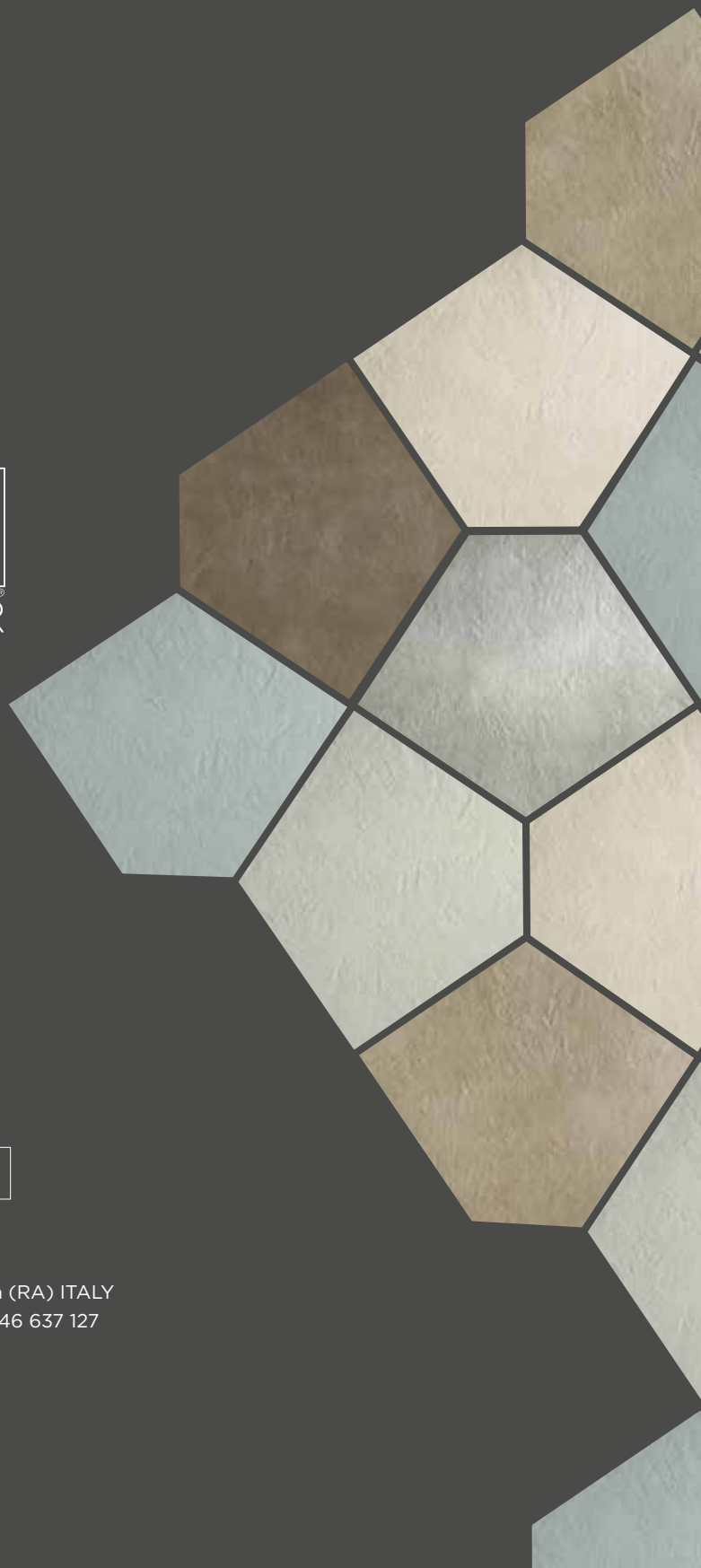

GIGACER S.P.A.  
via Caltagirone, n.72 / 48018 Faenza (RA) ITALY  
Tel. +39 0546 637 111 / Fax +39 0546 637 127  
info@gigacer.it

[gigacer.it](http://gigacer.it)